

Pneumatiskt manöverdon "AIR-ON"

Pneumatic actuator "AIR-ON"



Beskrivning

 AIR-ON pneumatiskt manöverdon i "Rack-and-pinion" utförande. Finns i dubbelverkande och enkelverkande (fjäderretur) utförande. Hus av anodiserat aluminium. Gavlar av aluminium med polyester behandling för maximalt motstånd mot potentiellt aggressiva miljöer. Manöverdonet är självsmörjande. ISO-5211.

Description

 AIR-ON pneumatic acting actuator in "Rack-and-Pinion" execution. Available in double or single (spring return) actuation. Body in hard anodized aluminium. End caps in heavy duty die cast aluminium with polyester coating for maximum resistance against potentially corrosive elements. The actuator is self-lubricating. ISO-5211.



Pneumatiskt manöverdon "AIR-ON"

Pneumatic actuator "AIR-ON"

Teknisk information/Technical information

Min/Max. arb.tryck	Dubbel/Enkelverkande 2–8,5 Bar
Min/Max. work.pressure	Double/Single acting 2–8,5 Bar
Temp. område standard	-20°C–80°C
Temp. range standard	-20°C–80°C
Alt. temp. område	1) -35°C–80°C 2) -20°C–150°C
Optional temp. range	1) -35°C–80°C 2) -20°C–150°C
Vridningsgrad	90° med standard justerskruv för +/- 5°
Movement	90° with standard adjustable screws +/- 5°



 **Topp-montage enl. VDI/VDE3845 Namur standard. För enkelt montage av brytarboxar och lägesställare.**

 Top mounting acc. to VDI/VDE3845 Namur standard allows easy installation of limit switches and positioners.



 **Oktagon med undre hålbilds anslutning enl. ISO-5211 och DIN3337 för direktmontage av ventiler.**

 Bottom mounting connection acc. to ISO-5211 and DIN3337 standard for direct mounting of valves. Star drive and square insert allows easy installation of the actuator directly.





 **Hålbild enl. VDI/VDE3845 Namur standard för sid- och direktmontage av Magnet/Namurventil.**

 Side mounting connection is designed acc. to VDI/VDE3845 Namur standard for direct mounting of solenoid valve.

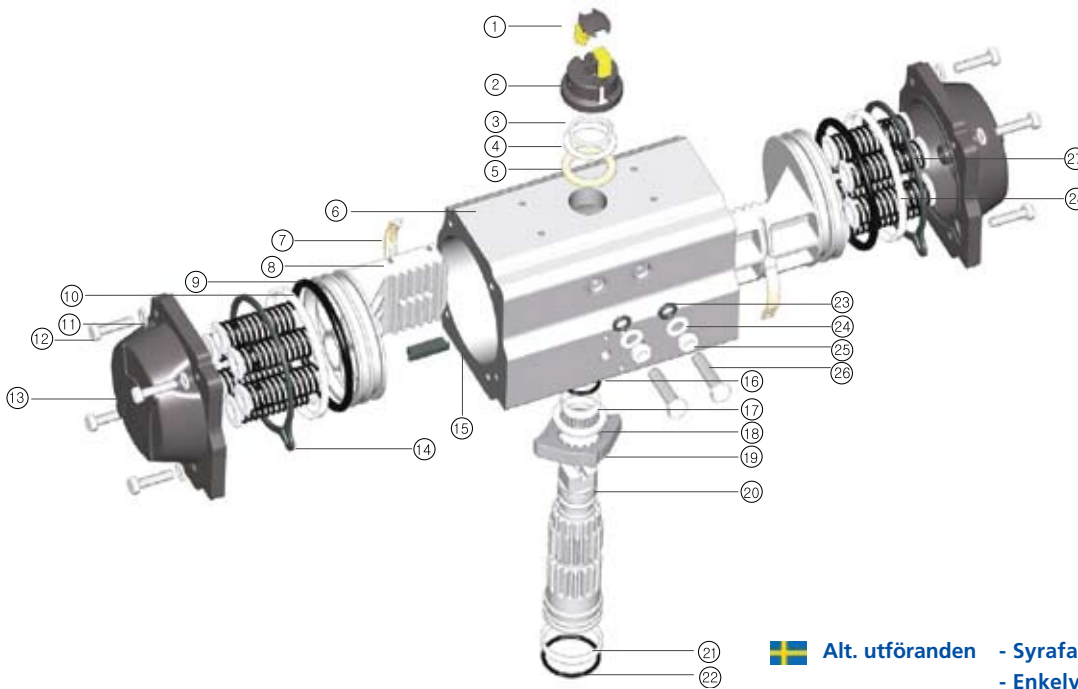
Pneumatiskt manöverdon "AIR-ON" Pneumatic actuator "AIR-ON"



-  **Alt. utföranden** - Syrafast stål
- Enkelverkande (Fjäderretur)
- 180° utförande
-  **Alt. executions** - Acid resistand stainless steel
- Single acting (Spring return)
- 180° execution

Material/Materials			
Delar/ Parts.no:	Antal/ Quantity	Produktdelar/ Part Description	Standard/ Standards
1	4	Lägesindikering/ Position indicator	Polypropylene
2	1	Lägesindikeringshållare/ Position indicator holder	Polypropylene
3	1	Fjäderbricka/ Spring Clip (pinion)	Stainless steel
4	1	Stötbricka/Thrust washer	Stainless steel
5	1	Stötlager/Thrust bearing	Polyphthalamide
6	1	Hus/Body	Aluminium/Aluminium
7	2	Kolvlager/Piston bearing	Polyphthalamide
8	2	Kolv/Piston	Aluminium/Aluminium
9	2	O-ring/O-ring	Nitril/Nitrile (NBR)
10	2	Kolvlager/Piston bearing	Polyphthalamide
11	8	Bultbricka/Cap bolt washer	Stainless steel
12	2	Gavelskruv/Cap bolt	Stainless steel
13	2	Husgavlar/End Caps	Aluminium/Aluminium
14	2	O-ring Gavel/O-ring end cap	Nitril/Nitrile (NBR)

Material/Materials			
Delar/ Parts.no:	Antal/ Quantity	Produktdelar/ Part Description	Standard/ Standards
15	2	Kolvstyrning/Piston guide	Polypropylene
16	1	O-ring/O-ring (top)	Nitril/Nitrile (NBR)
17	1	Lager/Bearing (top)	Nylon 46/Nylon 46
18	1	Stötlager/Thrust bearing	Polyphthalamide
19	1	Öppet - Stängt ändlägen/ Open - Close Cam (stops)	Stainless steel
20	1	Drivaxel/Drive shaft	Stål, legerat/Steel Alloy
21	1	Kolvlagar (botten)/ Bearing (Piston bottom)	Nylon 46/Nylon 46
22	1	O-ring (bottendrev)/ O-ring (pinion bottom)	Nitril/Nitrile (NBR)
23	2	O-ring skruv/O-ring stop bolt	Nitril/Nitrile (NBR)
24	2	Stoppbricka/Stop bolt washer	Stainless steel
25	2	Stoppmutter/Stop nut	Stainless steel
26	2	Stopskruv/Stop bolt	Stainless steel
27	Min. 5/Max. 12	Fjäder/Spring (cartridge)	Stål, legerat/Steel Alloy
28	1	Fjäderhållare/Spring holder	Polypropylene

Rätt till tekniska ändringar förbehålles. Subject to changes Änderungen vorbehalten 2009-01-26

Pneumatiskt manöverdon "AIR-ON" Pneumatic actuator "AIR-ON"

BPS 8300035DA

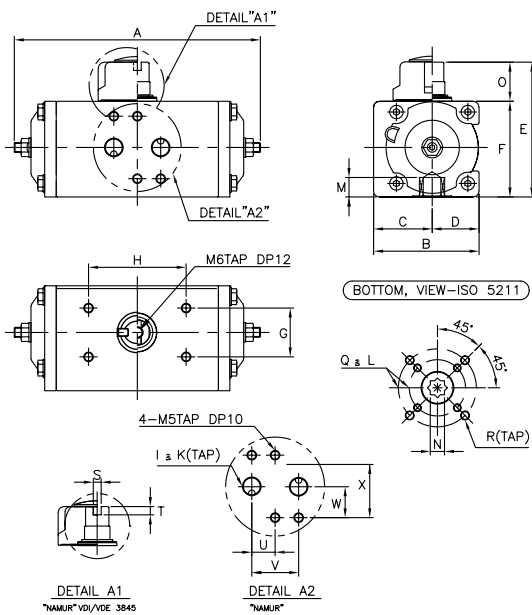

BPS 8300050DA - 8300200DA

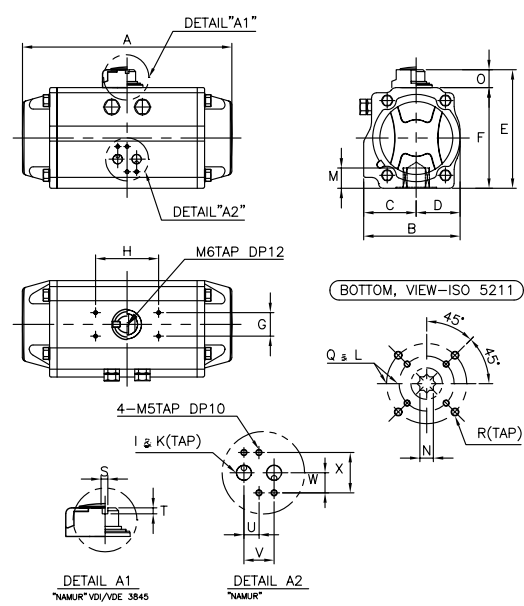

BPS 8300DA Dubbelverkande / Double acting

Art. nr	ISO-5211		A	B	C	D	E	F	G	H	J	O	P	Nm (6 bar)	Kg
	Q	R M/N (Min.)													
BPS 8300035DA	F03/F05 Ø36/Ø50	M5/M6 10/9	125	54	24	30	76	48	25	50	M6	20	41,5	8,7	0,50
BPS 8300050DA	F03/F05 Ø36/Ø50	M5/M6 12/11	142	72	30	42	100	72	30	80	M6	20	41,5	20	1,2
BPS 8300063DA	F05/F07 Ø50/Ø70	M6/M8 16/14	162	84	37	47	113	85	30	80	M6	20	41,5	35,3	1,7
BPS 8300075DA	F05/F07 Ø50/Ø70	M6/M8 19/17	208	96	42,5	53,5	131	103	30	80	M6	20	41,5	69,9	3,0
BPS 8300088DA	F05/F07 Ø50/Ø70	M6/M8 19/17	246	108	49,5	58,5	144	116	30	80	M6	20	41,5	110,1	4,3
BPS 8300100DA	F07/F10 Ø70/Ø102	M8/M10 22/17	266	123	56	67	156	128	30	80	M6	20	41,5	160,3	5,9
BPS 8300125DA	F07/F10 Ø70/Ø102	M8/M10 24/22	347	151	69	82	196	159	30	80	M6	30	41,5	333	11,3
BPS 8300160DA	F10/F12 Ø102/Ø125	M10/M12 29/27	475	202	101	101	233	197	30	80	M6	30	41,5	682	22,0
BPS 8300200DA	F14 Ø140	M16 38/36	570	232	116	116	274	246	30	130	M6	50	N.A	1277	38,4

Pneumatiskt manöverdon "AIR-ON" Pneumatic actuator "AIR-ON"

BPS 8300050SR-8300200SR

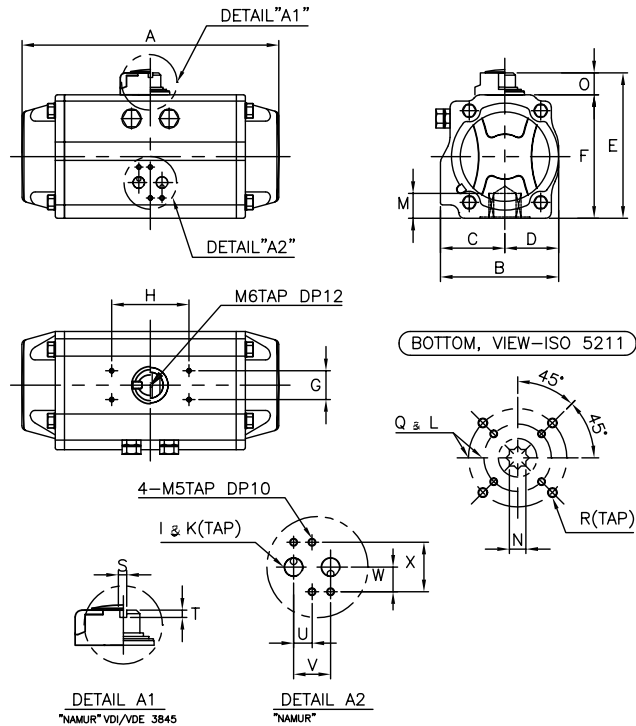

BPS 8300SR Enkelverkande (Fjäderretur) / Single acting (Spring return)																
Art. nr	ISO-5211	R	A	B	C	D	E	F	G	H	J	O	P	Nm (6 bar)	Nm (Fjäder/spring)	Kg
	Q	M/N (Min.)														
BPS 8300050SR	F03/F05 Ø36/Ø50	M5/M6 12/11	142	72	30	42	100	72	30	80	M6	20	41,5	11,9	8,1	1,3
BPS 8300063SR	F05/F07 Ø50/Ø70	M6/M8 16/14	162	84	37	47	113	85	30	80	M6	20	41,5	22,6	13,3	1,9
BPS 8300075SR	F05/F07 Ø50/Ø70	M6/M8 19/17	208	96	42,5	53,5	131	103	30	80	M6	20	41,5	42,4	26,5	3,3
BPS 8300088SR	F05/F07 Ø50/Ø70	M6/M8 19/17	246	108	49,5	58,5	144	116	30	80	M6	20	41,5	66,6	44,0	4,9
BPS 8300100SR	F07/F10 Ø70/Ø102	M8/M10 22/17	266	123	56	67	156	128	30	80	M6	20	41,5	103,0	60,8	6,8
BPS 8300125SR	F07/F10 Ø70/Ø102	M8/M10 24/22	347	151	69	82	196	159	30	80	M6	30	41,5	206,5	126,0	11,5
BPS 8300160SR	F10/F12 Ø102/Ø125	M10/M12 29/27	475	202	101	101	233	197	30	80	M6	30	41,5	411,9	269,0	22,4
BPS 8300200SR	F14 Ø140	M16 38/36	570	232	116	116	274	246	30	130	M6	50	N.A	766,1	510,0	39,2

Rätt till tekniska ändringar förbehålles. Subject to changes Änderungen vorbehalten 2009-01-26